

2003 QWEST® AND EAGLE™ CAMPING TRAILERS BY JAYCO



Building Family Fun for 35 Years

June 18

Hi Deb,

Spent our first night at Crater Lake Nat'l Park in Oregon. So much better than last year. Finally got rid of the ratty tents and got a good deal on a Jayco camper. Beats sleeping on the ground!

Last night was nice. Settled in, pulled down the shades, turned on the lights and relaxed. Wiped out after the 5 hr. drive. Nicki and Curtis were getting restless. Our Qwest has bunk privacy curtains so John and I got some time alone (for a change!).

Weather was so good this morning we took the range and the dinette outside and made bacon and eggs in the screen room. Then drove Rim Drive around the lake. It's so blue! Going to take a boat tour later. And go hiking. Mt. Scott is almost 9,000 ft.

Thanks for feeding Misty for us while we're gone.
See you next week!

Monica

Jayco® was proud to participate in and serve as the official recreational vehicle of The Park Programs/Summer-Fun Sweepstakes in 2002, involving our nation's National Parks.



Simply unplug the two-burner range and plug it in outside for an outdoor dinner.





Enjoy the outside air in your optional deluxe screen room. Roll-down tent panels give you extra privacy or protection against bad weather.

Color-coordinated SoftShade™ window shades and valances are easy to operate and easy to clean.



Choose the optional attractive, matching bunk privacy curtains when you want a little time alone.

Qwest® 12 A with optional deluxe screen room

Stand tough against whatever comes your way

Jayco® has been building family fun for 35 years, and building rugged vehicles that pack in a lot of value. Qwest® camping trailer delivers dependable value by giving you a lot of durability and toughness for little money. We start with a **Structurwood® floor** that seals and protects the bottom. Then we build the **double-wall sidewalls** to withstand bumps and dings. We top it with a **true-domed aluminum roof** that shrugs off the elements and a **ceiling that resists mildew**. **Wall-to-wall, color-coordinated vinyl flooring** repels stains and cleans easily. Optional **hydraulic surge brakes** or **electric brakes** on 8' and 10' models add braking power to these smaller models.

Even though Qwest is tough, it also has a soft side to make your family's stay easier. **Stabilizer jacks** are easy to reach and to crank-down to give you a solid base. And the **self-storing step** simply folds out of the way when you're ready to travel.

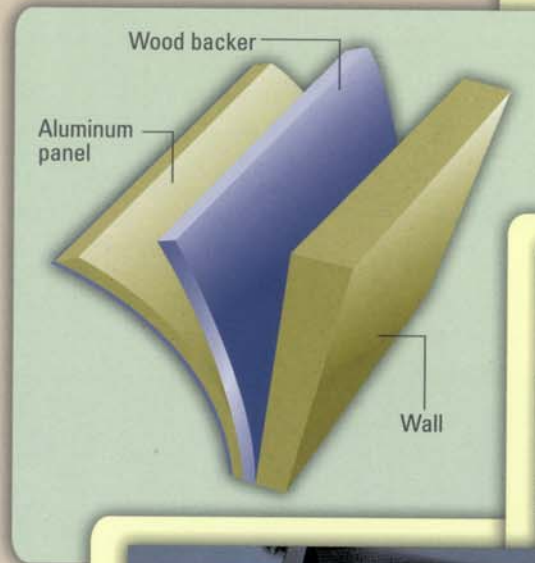

Vacuum-bond laminated, double-wall construction, made from thick .024" aluminum with wood backers, makes sidewalls strong so they won't bow or dent as easily. Unlike other manufacturers, we also make sidewalls strong by screwing them through both the floor and the frame.



The optional self-storing step makes climbing in and out safe and easy.



The easy-to-use crank-down stabilizer jacks mean you won't have to crouch down as far and reach underneath the camper. (Standard on rear. Front and rear standard on Qwest 12A.)



The single-piece Structurwood floor is undercoated and edge-sealed to keep out moisture and stand strong for years.



An optional color-coordinated wheel cover protects your spare.



Quest® 12A interior

An optional color-coordinated gas bottle cover protects and enhances your camper's good looks.

Gain more space, more comfort,
more of what you enjoy

Dream Lake, situated beneath Hallett peak and the Crags on Flattop Mountain, is a glacially formed subalpine lake of unsurpassed beauty located in Rocky Mountain National Park.

July 8

Craig —
Camping at Glacier Basin in Rocky Mt. Nat'l Park. 8,000' up. Took a while to acclimate. Set up the canopy and rested. Good thing it was easy — no stupid tent poles — 'cause we were winded. Maria crashed on the sofa. Then we climbed Lumpy Ridge — best granite climb. View from top was worth it! Also great views along Trail Ridge Road. Lots of snow-capped peaks. Good thing I got the Eagle. More room for gear. After climb, cleaned off at the outside shower and saw some elk down by Glacier Creek. Also seen big horn sheep ... even a moose.

Show you pics when we get back.
James



To: Craig Davis
404 Oak St.
Zephyr Springs, MI
50100

SPACE BELOW RESERVED FOR U.S. POSTAL SERVICE

Made in
Canada



Move dinner outdoors with the portable three-burner range (or two-burner range depending on model).

Our innovative galley design folds over easily to stow and secures all your utensils during travel.



The optional deluxe plumbing package (not available on Eagle™ 10 SG) includes a water heater, demand pump and this outside shower with hot and cold faucets, rugged ABS plastic hose and shower head.

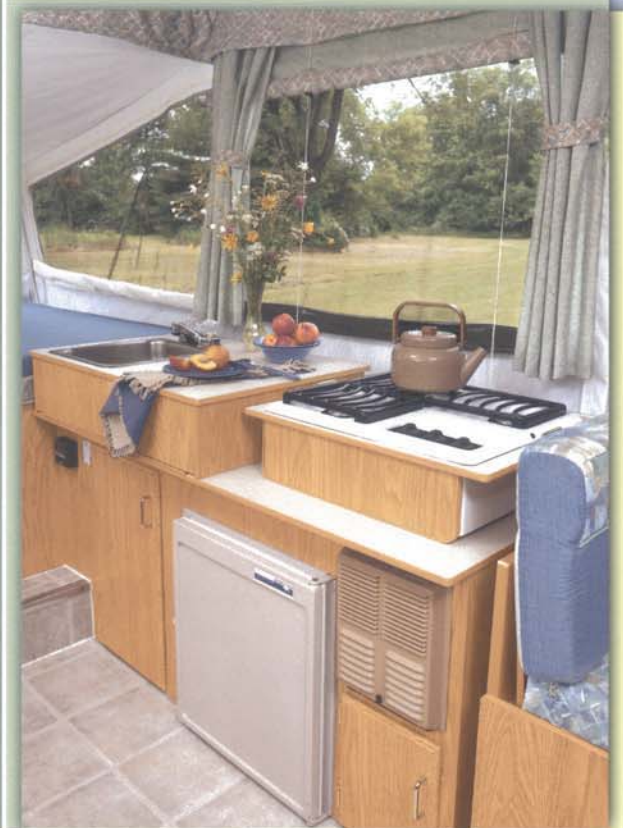

Eagle™ 12 F50 interior

No more huddling next to a lantern or finding a place for a fan. One or two optional end bunk lights, combined with a built-in two-speed fan, give you ample light at night and better ventilation.



Our beautiful, lighter Fairfield Oak cabinets have the strength to last. We build cabinet doors using traditional, strong mortise-and-tenon joints. And we use real-wood drawers, not plastic tubs.

Eagle™ Camping Trailers



*Eagle™ 10 UD with optional
deluxe screen room*

Color-coordinated
SoftShade™ window
shades and valances
add an attractive
touch.



Get your own space with optional
matching bunk privacy curtains.

Take it all in

Whether you're heading to the Rocky Mountains or to Death Valley, Eagle™ camping trailer makes sure you've got everything your family needs to have fun in your vacation spot. In the kitchen, the optional **wrapped galley with L-shaped dinette** offers seating convenience not seen in other camping trailers.

A **silverware tray** (some models) organizes your utensils just like home. Throughout the interior, **SoftShade™ window shades and valances** shield you from the sun. You can carry everything your family needs in the **SofStor™ storage system** without cluttering the inside. Store your coolers, tackle boxes and lawn chairs in the spacious **front trunk**.

Step out the strong **one-piece entrance door** and into the optional **screen room**, which guards against pesky bugs, and enjoy the fresh air. When it's time to head to the dump station, just pull out the **wheeled, portable gray water tank** (some models) and you won't have to fold up and haul the whole camping trailer.



The one-piece entrance door is stronger and fits better than two-piece doors and is easier to use.

An optional color-coordinated wheel cover and gas bottle cover protects and enhances your camper's good looks.



With more than 20 cu. ft. of storage space, Eagle's front trunk gives you plenty of space so you won't have to leave your gear out in the weather or take up valuable inside space.



Jayco®'s optional SofStor storage system keeps your necessities out of the way but within easy reach. Choose from the SofStor Wardrobe with removable shelves for clothing, the Organizer for shoes and other small items and the Overhead galley cabinet for food and other essentials.

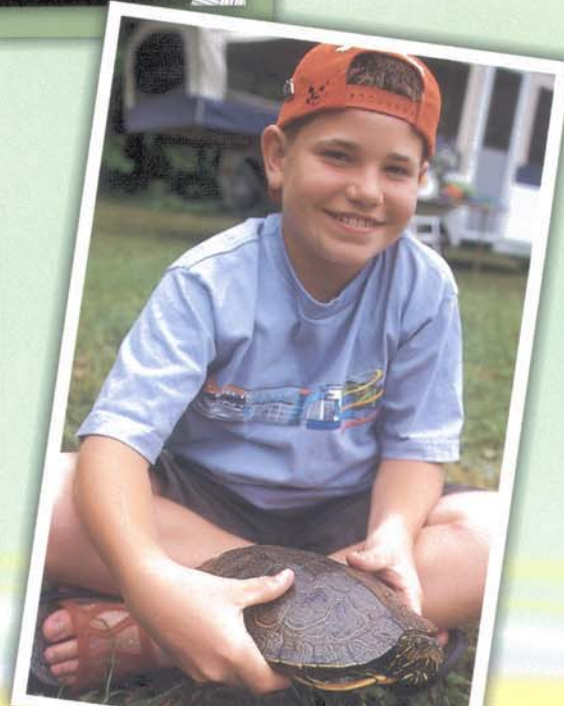

Be prepared for the road ahead

You never know what obstacles you'll encounter during your trip. That's why we build Eagle™ to handle whatever comes your way. **Vacuum-bond, laminated double-wall sidewalls** resist bowing and denting. And the **24" sidewall height** allows for taller windows, giving you a greater outdoor view. **Front and rear ABS caps and skirting** not only look great, but they also stand tough against road debris.

Eagle is equally tough beneath the surface. **High-density polyethylene wheel wells** are lighter than metal and more impact- and corrosion-resistant. The **TorFlex® suspension** absorbs bumps better than springs. The innovative designs of our **patented lifter system** let you easily raise and lower the roof through years of use. We've even made the roof deeper to give more room for the folded tent when lowered and hidden the optional **A/C prep wiring** in a roof channel for a more attractive interior.

Inside, the **Fairfield Oak cabinets** are built to last using traditional construction methods. The **vinyl-backed dinette cushions** last through spills and messes by simply wiping clean. When you come back a mess after a muddy hike, listen to the optional **cassette or CD AM/FM stereo** while cleaning off in the optional **inside bath/shower combination** (some models).

Eagle's vacuum-bond laminated, double-wall construction, made from thick .040" aluminum with wood backers, makes sidewalls strong so they won't bow or dent as easily. Unlike other manufacturers, we also make sidewalls strong by screwing them through both the floor and the frame. And the TruForm® surface makes them scratch-resistant.

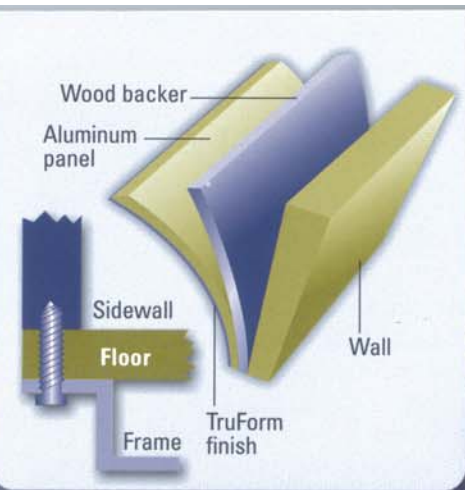

12 F50 Eagle



Eagle sports a streamlined look with front and rear ABS caps and radius fender skirting.



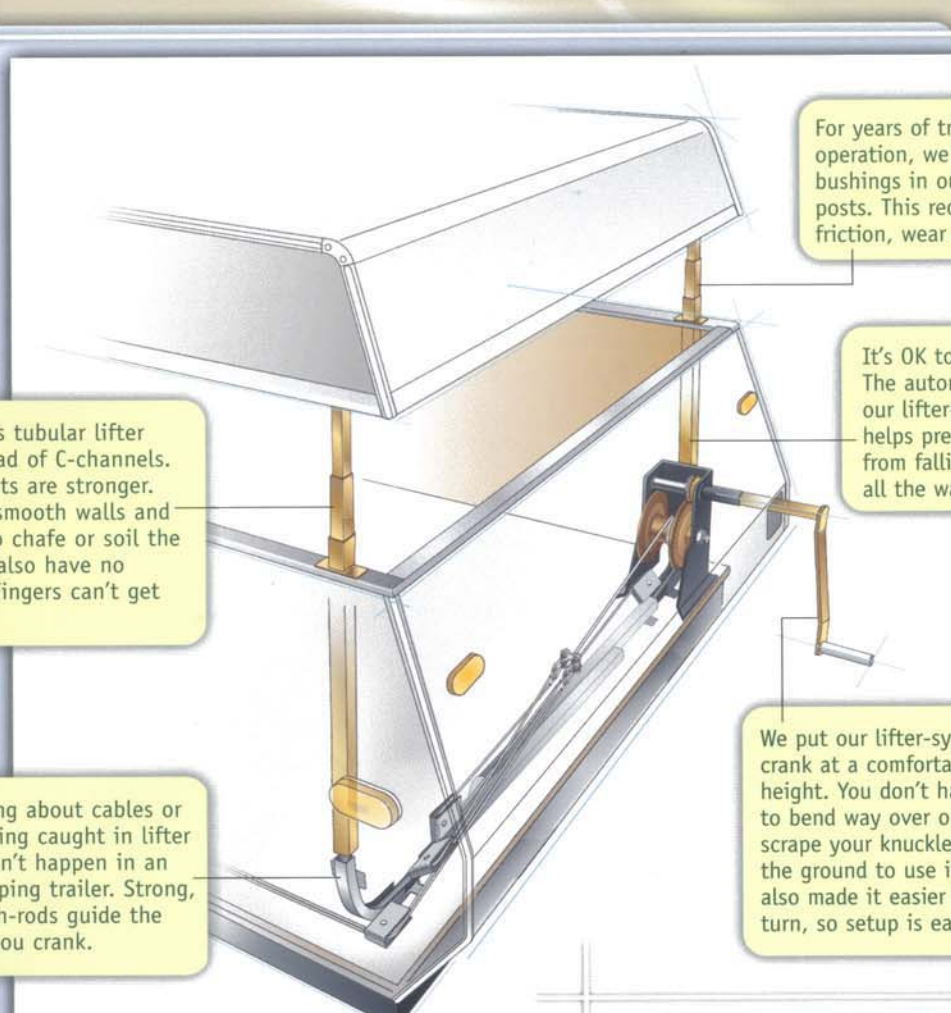

Jayco® uses tubular lifter posts instead of C-channels. Tubular posts are stronger. They have smooth walls and no edges to chafe or soil the tent. They also have no openings. Fingers can't get inside!

Stop worrying about cables or pulleys getting caught in lifter posts. It won't happen in an Eagle™ camping trailer. Strong, flexible push-rods guide the roof up as you crank.

For years of trouble-free operation, we use nylon bushings in our lifter posts. This reduces friction, wear and tear.

It's OK to stop cranking. The automatic brake on our lifter-system winch helps prevent the roof from falling before it's all the way up.

We put our lifter-system crank at a comfortable height. You don't have to bend way over or scrape your knuckles on the ground to use it. We also made it easier to turn, so setup is easy.



Rugged frames are protected from corrosion using a 12-stage E-Coat™ finishing system. The Z-shaped perimeter gives it unibody strength and stability and prevents floor sag. With a solid foundation, your Jayco® camper is built to withstand years of use.



The optional spare can come to the rescue so you're not left stranded.

Our new E-Z Lube® axles with removable caps make maintenance simple.

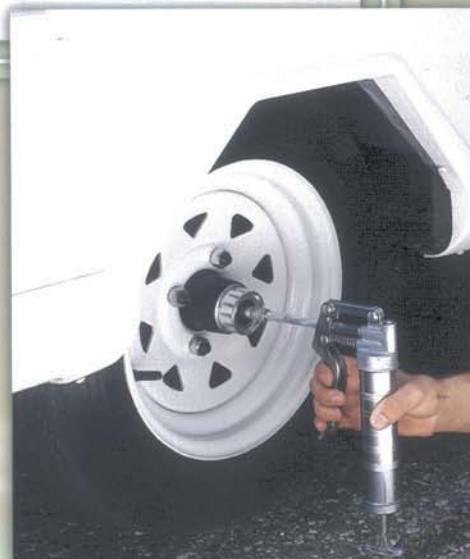

TorFlex® independent torsion-axle suspension gives Eagle™ a smooth ride, makes towing easier and reduces wear and tear by absorbing bumps better than standard springs. And with more ground clearance than leaf springs, you can take Eagle over terrain that's less than ideal.

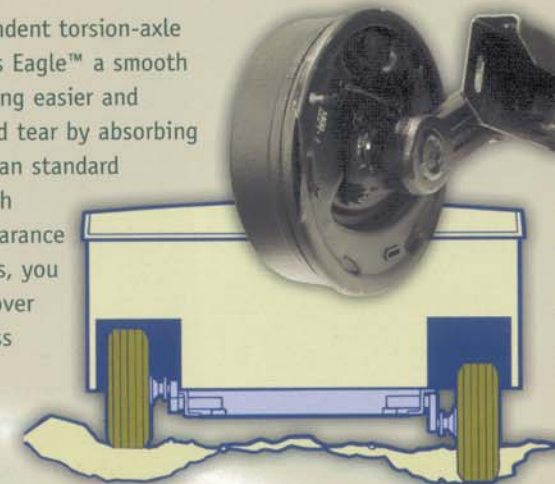

Standard and optional features to fit your lifestyle

Aug. 10 - Shenandoah National Park

Stayed in Big Meadow Campground. Views from the overlooks were awesome. Caught a 12" eastern brook trout on the Rose River, but it got away (Theresa still doesn't believe me!). So we grilled burgers outside for dinner instead. Lucky she put some meat in the fridge before we left. Kids went hiking. They saw Dark Hollow Falls and some big canyons. They want to go

on the Appalachian Trail today. Not sure I'm up to it!

Rainstorm hit last night and forced us inside. Our stuff didn't get soaked like last year because we stuck everything in these zipper bags that came with the camper and put it all behind the skirt under the bunks. Nice not to have to sit on wet lawn chairs this morning. Stayed dry inside, too. Vanessa and Tracy had kids over from another campsite. Piled everyone in when it started raining. Must have been ten kids in the front bunk. Derek retreated to the rear bunk!

Spending one more night. Then off to see Appomattox Court House and the Civil War battlefields around Fredericksburg before we head back.



Well-built end bunks handle loads of weight. Made from 5-ply exterior grade, weather-treated plywood, the bunks are mounted on a steel slide with smooth rollers to make setup easy. You can set up your camper in minutes without wearing yourself out, and with the confidence that it will hold up like it should.

Read, play a game or just talk into the night using the patio or porch light.



A large-capacity, self-draining ice box lets you keep food without needing a bulky cooler.

The reversible, non-slide dinette cushions with vinyl backs clean up easily. Simply wipe off or unzip to remove for thorough cleaning. To store things beneath, the hinged dinette seat bases lift easily with just one hand.



Our one-piece, double-stitched, water-repellent BoltaFlex CT™ tent closures employ Jayco's unique Velcro® system. As a result, they keep out bugs and drafts and stand up to the elements for years.



In the heart of the Midwest, old-world craftsmen have handed down tried-and-true construction methods from generation to generation. At our headquarters in Middlebury, Indiana, Jayco continues this tradition when building all of our recreational vehicles. Our rugged designs, solid construction and commitment to quality add up to a well-built vehicle you can depend on for years.



Optional KidStuf™ bunk organizers give kids a place for their toys, books and other items.



Store camping items such as folding lawn chairs, garden hoses, barbecue utensils or other dirty items in the optional OutStor™ organizers to keep the inside of your camper clean.



Also, protect additional stored items with removable vinyl bunk skirting.



Enjoy one of the things you miss most while camping with the optional bath/shower (Eagle™ models 12 F50, 12 UDST and 14 S0).



Choose the convenient 2-cu.-ft., 3-way (110V/12V/LP gas) Norcold® refrigerator.



Enjoy your favorite music anywhere with the optional AM/FM stereo with cassette or CD player and two ceiling-mounted speakers.



The optional portable gas barbecue grill lets you get that great grilled flavor. And it comes with a handy carrying case.



An optional 14" x 14" roof vent gives you more fresh air. And the roof is 2" deeper to give you more headroom and more space for the tent to fold down inside.



Sleek new 12V Command lighting provides ample interior light.

2003 Qwest® Camping Trailer Floorplans

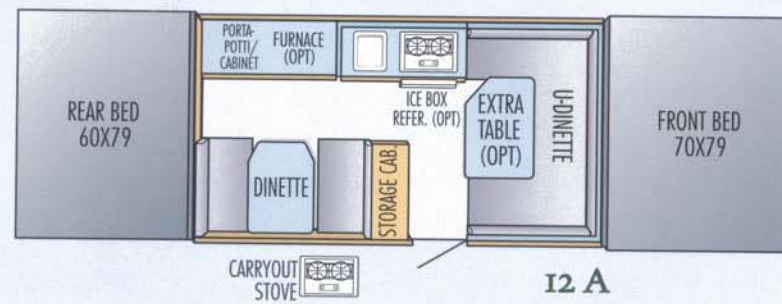
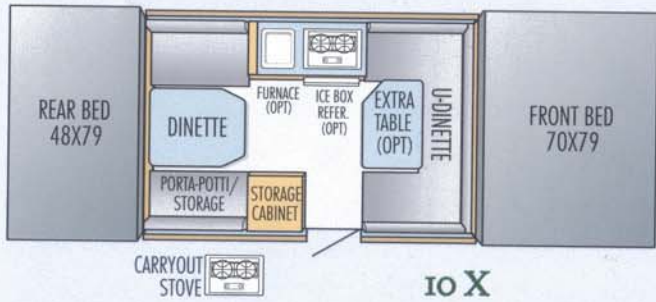
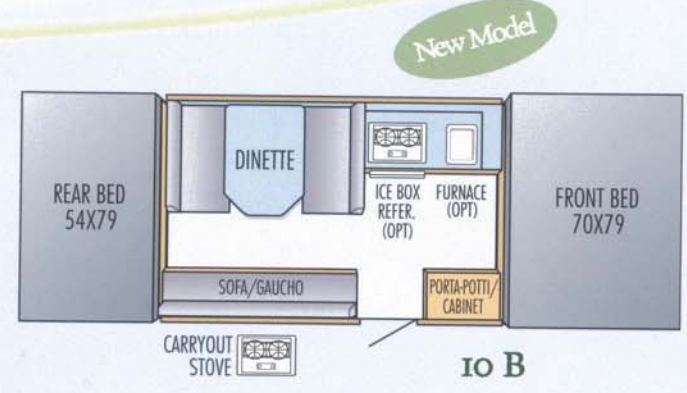
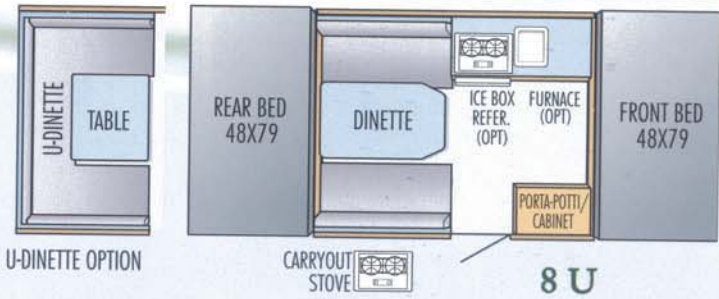

Qwest® Camping Trailer Specifications

Model	Travel Length	Campsite Length	Approx. Travel Height	Unloaded Vehicle Weight (w/std. equip.) (lbs.)	Approx. Hitch Weight (lbs.)	Axle Weight (lbs.)	Gross Vehicle Weight Rating (lbs.)	Cargo Carrying Capacity (w/out options) (lbs.)	Sleeping Capacity	Fresh Water Capacity (gals.)
8 U	12'	16'-3"	55 3/4"	1165	160	1005	1875	710	6	5
10 B	13'-10"	20'-7"	55 3/4"	1465	160	1305	2160	695	7	5
10 X	13'-10"	20'-1"	55 3/4"	1430	180	1250	2160	730	7	5
12 A	15'-10"	24'	55 3/4"	1610	205	1405	2700	1090	7	10

Unloaded Vehicle Weight (UVW): Sometimes referred to as "Dry Weight," UVW means the typical weight of this trailer as built at the factory. The UVW, as used in product literature and other promotional materials, does not include cargo, fresh water, LP gas, options or dealer-installed accessories.

Gross Vehicle Weight Rating (GVWR): GVWR means the maximum permissible weight of the trailer, including the UVW plus passengers, personal items, all cargo, fluids, options and dealer-installed accessories. The GVWR is equal to or greater than the sum of the UVW and the CCC.

Cargo Carrying Capacity (CCC): CCC means the maximum weight of all passengers, personal items, food, fresh water, LP gas, tools, other cargo and dealer-installed accessories that can be carried by the trailer. CCC is equal to or less than GVWR minus UVW.

*The addition of options will decrease the CCC.

It is important for your safety and enjoyment that your tow vehicle be adequately sized and equipped to tow and handle the GVWR of the RV you select. Review weights and rating of your tow vehicle and consult a competent advisor for questions

or advice. Whether you are new to RVing or a veteran, get a feel for the performance of your tow vehicle and the RV together before heading out on the roadways. **When you tow an RV, you must drive differently than you do when driving a single vehicle.** Practice hooking up, driving, backing up and braking in a safe environment or seek out professional instruction.

See specification chart above. Jayco affixes a weight label to each new RV which lists weight information for that vehicle.

2003 Eagle™ Camping Trailer Floorplans

New Model

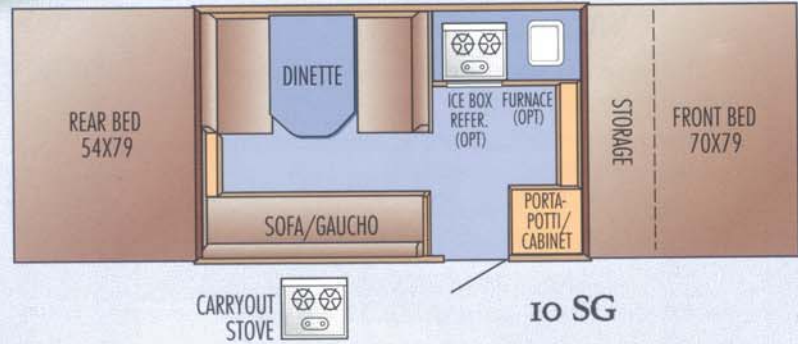
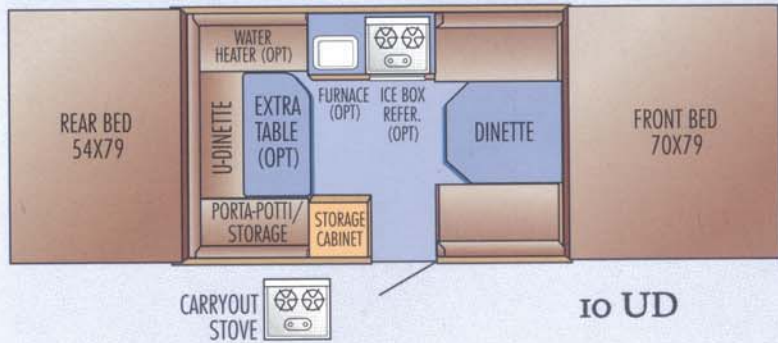

Eagle™ Camping Trailer Specifications

Model	Travel Length	Campsite Length	Approx. Travel Height	Unloaded Vehicle Weight (w/std. equip.) (lbs.)	Approx. Hitch Weight (lbs.)	Axle Weight (lbs.)	Gross Vehicle Weight Rating (lbs.)	Cargo Carrying Capacity (w/out options) (lbs.)	Sleeping Capacity	Fresh Water Capacity (gals.)
10 UD	14'-10"	21'-6"	53 3/4"	1520	155	1365	2310	790	7	5
10 SG	16'-10"	21'-6"	55"	1795	175	1620	2800	1005	7	5
12 UDST	18'-10"	24'	55"	2050	265	1785	2800	750	7	17
12 FSO	18'-10"	24'	55"	2235	285	1950	3000	765	7	17
12 SD	16'-10"	24'	55"	1950	180	1770	2700	765	6	17
14 SO	18'-10"	26'	57"	2675	280	2395	3330	655	7	17

Unloaded Vehicle Weight (UVW): Sometimes referred to as "Dry Weight," UVW means the typical weight of this trailer as built at the factory. The UVW, as used in product literature and other promotional materials, does not include cargo, fresh water, LP gas, options or dealer-installed accessories.

Gross Vehicle Weight Rating (GVWR): GVWR means the maximum permissible weight of the trailer, including the UVW plus passengers, personal items, all cargo, fluids, options and dealer-installed accessories. The GVWR is equal to or greater than the sum of the UVW and the CCC.

Cargo Carrying Capacity (CCC): CCC means the maximum weight of all passengers, personal items, food, fresh water, LP gas, tools, other cargo and dealer-installed accessories that can be carried by the trailer. CCC is equal to or less than GVWR minus UVW.

*The addition of options will decrease the CCC.
It is important for your safety and enjoyment that your tow vehicle be adequately sized and equipped to tow and handle the GVWR of the RV you select. Review weights and rating of your tow vehicle and consult a competent advisor for questions

or advice. Whether you are new to RVing or a veteran, get a feel for the performance of your tow vehicle and the RV together before heading out on the roadways. **When you tow an RV, you must drive differently than you do when driving a single vehicle.** Practice hooking up, driving, backing up and braking in a safe environment or seek out professional instruction.

See specification chart above. Jayco affixes a weight label to each new RV which lists weight information for that vehicle.

2003 Eagle™ Camping Trailer Floorplans – Cont.

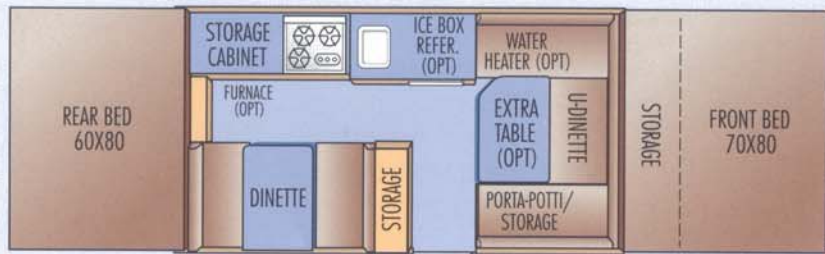

12 UDST



BATH/SHOWER OPTION



J-FLEX™ SOFA OPTION

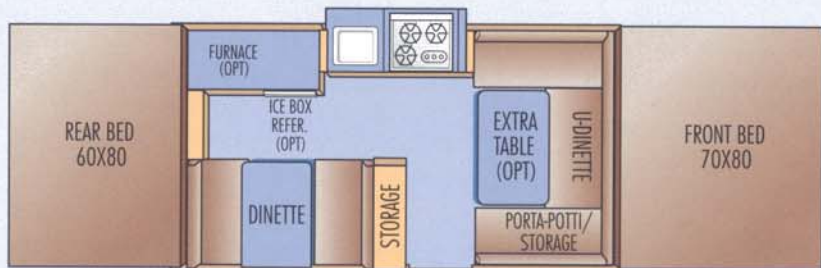

12 SD



CASSETTE TOILET ONLY OPTION

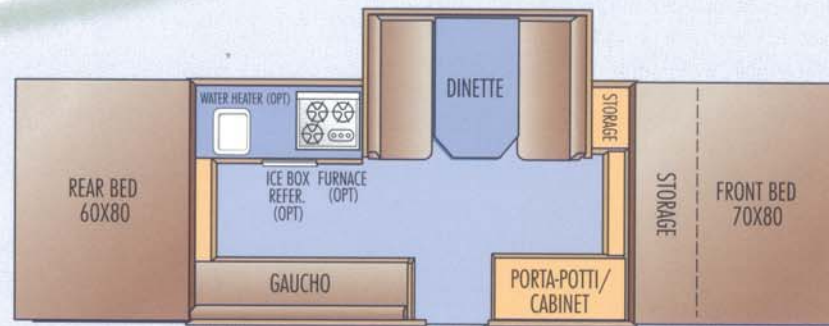

12 FSO



BATH/SHOWER OPTION



CASSETTE TOILET ONLY OPTION

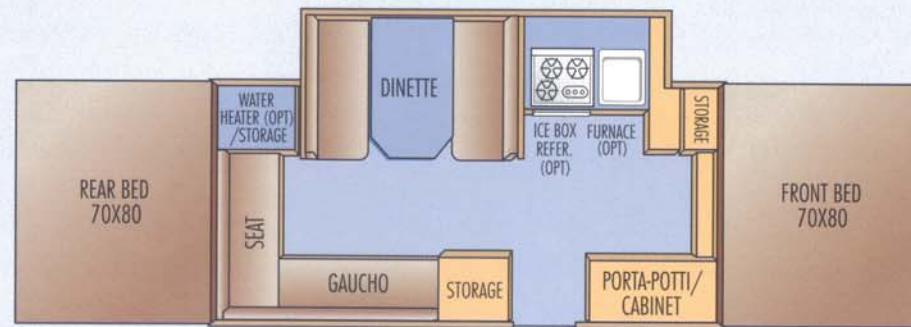

14 SO



BATH/SHOWER OPTION



CASSETTE TOILET ONLY OPTION

2003 Qwest® & Eagle™ Camping Trailer Standards and Options

STANDARD EXTERIOR FEATURES

	QWEST® CAMPING TRAILER	EAGLE™ CAMPING TRAILER
Crank-down stabilizer jacks (4) (8' & 10' models: 2 std., 2 opt.)	■	■
High-flotation C-Range 13" tires (All 12' models & 10 SG)	■	■
C-Range 12" tires (8', 10', 14' models)	■	■
Outside porch light w/awning light adapter	■	■
Patio light w/bright lens (10 X, 12 A)	■	■
Clearance lights (11)	■	■
30-ft. 30-amp. power cord	■	■
110V G.F.C.I. - protected exterior receptacle (except 8 U)	■	■
Heavy-duty Aframe leveling jack	■	■
Welded steel bumper	■	■
Entrance door opens when roof is down	■	■
Wide-body construction	■	■
Front trunk storage (12 FSO, 12 UDST & 10 SG)	■	■
Light in front trunk	■	■
Prep for battery	■	■
Lifter post covers	■	■
Patented, fully enclosed lifter system	■	■
20-lb. LP gas bottle	■	■
True-domed aluminum roof	■	■
TruForm® scratch-resistant finish	■	■
E-Coat™ frame protection	■	■
Self-storing step (12', 14' models)	■	■
BoltaFlex CT™ water-repellent tent material	■	■
Undercoated, edge-sealed Structurwood® floor	■	■
Electric brakes (12', 14' models)	■	■
E-Z Lube® Axles	■	■
One-piece entrance door	■	■
Front & Rear ABS caps/radius skirting	■	■

STANDARD INTERIOR FEATURES

	QWEST® CAMPING TRAILER	EAGLE™ CAMPING TRAILER
Fire extinguisher	■	■
LP leak detector	■	■
Wall-to-wall, color-coordinated vinyl flooring	■	■
Real wood drawers with nylon guides	■	■
Brass door pulls w/roller catch	■	■
4"-thick end-bunk cushions	■	■
Reversible, non-slide 4" thick dinette cushions w/easy-clean vinyl backs	■	■
SoftShade™ window shades and valances	■	■
Tinted windows	■	■
12V high-intensity lighting	■	■
Automatic cut-off switch for interior lights	■	■
110V G.F.C.I. - protected interior receptacles	■	■
Mildew-resistant aluminum ceiling	■	■
Adjustable-tension end bows	■	■
Bed flaps	■	■
Hinged dinette seat bases	■	■

STANDARD GALLEY FEATURES

	QWEST® CAMPING TRAILER	EAGLE™ CAMPING TRAILER
Stainless steel sink with faucet hold-down	■	■
Large-capacity, self-draining insulated ice box	■	■
White-enamel carryout stove (2- or 3-burner, depending on model)	■	■
Pre-plumbed for LP gas appliances	■	■
Carryout dinette table	■	■
12V electrical system with 20-amp. 110V converter	■	■
12V electrical system with 12-amp. 110V converter	■	■
City water hookup (12', 14' models; country water fill)	■	■
Fresh water tank below floor (12', 14' models)	■	■
5-gal. fresh water tank (8 U, 10 X, 10 SG, 10 UD)	■	■
10-gal. fresh water tank (12 A)	■	■

OPTIONAL FEATURES

	QWEST® CAMPING TRAILER	EAGLE™ CAMPING TRAILER
Spare tire	■ ✓	■ *
Vinyl spare tire cover	■	■
Outside portable gas barbecue grill w/carrying case	■	■
Hydraulic surge brakes	■	■
Electric brakes (Qwest® 10 UD, 10 SG)	■	■
Canopy/screen room/deluxe screen room	■	■
Deluxe canopy	■	■
Self-storing step (Qwest® 10 UD, 10 SG)	■ ✓	■
Prep for air conditioning	■	■ *
2-cu.-ft. 110V/12V/LP gas refrigerator	■	■
Vinyl gas bottle cover	■ ✓	■ *
16,000-BTU furnace with auto-ignition	■	■
End-bunk lights w/ fan (2)	■	■ *
KidStuf™ bunk organizer	■	■
J-Flex™ Sofa in lieu of dinette (12 UDST)	■	■
Silverware tray (select models)	■	■
J-Flex™ Sofa in lieu of gaucha (12 UDST)	■	■
Extra dinette table w/pedestal leg (10 UD, 12 UDST, 12 SD, 10 X, 12 A)	■	■
U-dinette in lieu of standard dinette (8 U)	■	■
SofStor™ Overhead storage (1 or 2)	■	■
SofStor™ Wardrobe storage	■	■
SofStor™ Organizer	■	■
OutStor™ Storage package	■	■
Removable vinyl bunk skirt	■	■
End-bunk privacy curtains	■ ✓	■ *
14" x 14" roof vent	■ ✓	■ *
10-gal. fresh water tank (10 UD, 10 SG)	■	■
Front stabilizer jacks (8' & 10' models)	■	■
Bath/shower package	■	■
(includes privacy curtain and Deluxe Plumbing Package/12 FSO, 12 UDST, 14 SO)	■	■
Deluxe plumbing package	■	■
(includes water heater, demand pump and outside shower; N/A on 10 SG)	■	■
AM/FM cassette or CD stereo	■	■
Cassette toilet (12 FSO, 12 SD)	■	■
Portable gray water tank (N/A 10 UD, 12 UDST)	■	■

✓ These options are part of the Convenience Group for Qwest

* These options are part of the Convenience Group for Eagle

2003 Qwest® and Eagle™ Camping Trailers

WE BACK WHAT WE BUILD

The Jayco 2+3 Warranty is a manufacturer's warranty. It doesn't come from your dealer and it's not an extended warranty! It comes from the people who build Jayco recreational vehicles to the people who buy them. Each Jayco is warranted to the original purchaser for twenty-four (24) months from the date of purchase against defects in materials and workmanship. This is full hitch-to-bumper coverage on towables and bumper-to-bumper on motorized RVs. The Jayco warranty includes a three-year (3) structural guarantee. In addition, our warranty is transferable within the first two (2) years for a \$100 processing fee. Go ahead and compare the Jayco warranty with other manufacturers' warranties. You'll find it's the best in the business! For a copy of the warranty with full terms and conditions, ask your local Jayco dealer or visit our Web site.

Lifetime Coverage

On all camping trailers, Jayco offers to the original purchaser additional industry-leading lifetime parts and labor coverage on our lifter system, roof, floor and frame. We also offer five-year (5) coverage on our tent with parts, labor and freight covered the first two years; parts, factory labor and return freight during years three, four and five.

Jayco® delivers responsive, reliable after-market customer service



for customers who need assistance during their travels through Indiana.

The Parts and Warranty divisions take advantage of our Jayco Xpress online computer network that links Jayco Customer Service to dealers across the country and allows

When you purchase a Jayco Recreational Vehicle, you'll also get a support staff dedicated to meeting the needs of you and your dealer. To deliver on this promise, we built a 91,000-square-foot, state-of-the-art facility that seamlessly integrates our Warranty, Customer Service and Service Parts divisions (After Market Services — AMS). Staff from each division can now work more closely together to better provide prompt, accurate service.

For example, the AMS staff can quickly access information on the computer and service representatives can better serve the needs of Jayco dealers and retail customers. Our service area contains 15 bays that feed into a spacious work area

them to place parts orders, check the status of an order and check pricing and availability. Dealers participating in the online system can also register new Jayco owners 24 hours a day, seven days a week. That way, when you pull off the dealer's lot, your new unit is already registered with the factory.

Our parts warehouse, equipped with automated carousels and stocked with a large inventory of parts, can provide our dealers with the parts you need so you can get back on the road to enjoying your vacation.

You won't find a more caring after-market service group in the recreational vehicle industry. That's our goal and commitment to you.

See above dealer for further information and prices.



Jayco, Inc. P.O. Box 460 Middlebury, IN 46540
www.jayco.com



As a Jayco owner, you can be part of the Jayco Jafari International Travel Club. Ask your dealer about the Jafari "flight" in your area, write Jayco direct or visit our Web site.

Please Note: All information in this brochure is the latest available at the time of publication approval. Jayco reserves the right to make changes and to discontinue models without notice or obligation.

Pictures in this brochure may show optional equipment. RVs built for sale in Canada may differ to conform to Canadian codes.

Printed on recycled paper.



©2002 Jayco, Inc. 0902-125M Litho in U.S.A.